

High performance on face milling operations



Facing



Slanted Shoulder
& Chamfer



PLUS
90845 | 90945 | 91245

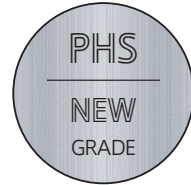

INSERT SIZE
05 ON...
0505



INSERT SIZE
06 ON...
0606



INSERT SIZE
12 SN...
1206



INSERT SIZE
16 SN...
1606



SINCE 1916

P M K S

INSERT SIZE
05 ON...
0505

ONHX-LP
ONKX-LP

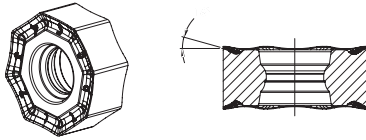

ONHX-MP
ONKX-MP

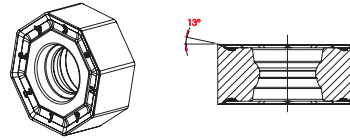

ONHX-MK
ONKX-MK

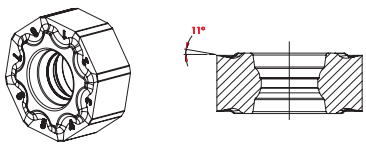

ONHX-W

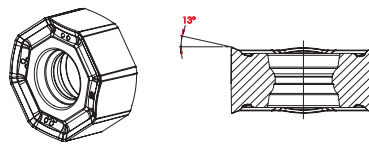

ONHX-LP
ONKX-LP



ONHX-MP
ONKX-MP



ONHX-MK
ONKX-MK



ONHX-W



P M K N S

INSERT SIZE
12 SN...
1206

SNHX-LP

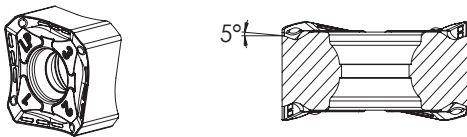

SNHX-MP
SNKX-MP

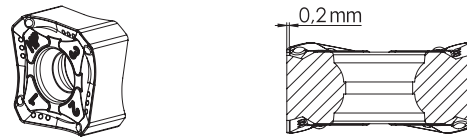

SNHX-MK
SNKX-MK

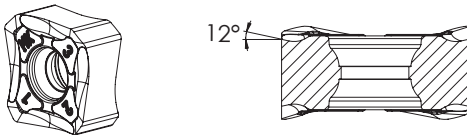

SNHX-LN

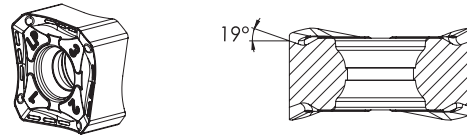

SNHX-W

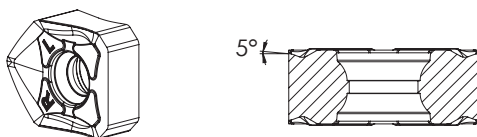

SNHX-LP



SNHX-MP
SNKX-MP



SNHX-MK
SNKX-MK



SNHX-LN



SNHX-W





INSERT SIZE
06 ON...
0606

ONHX-LP
ONKX-LP

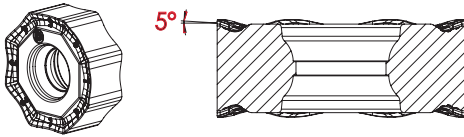

ONHX-MP
ONKX-MP

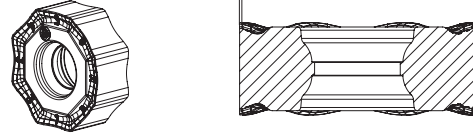

ONHX-W

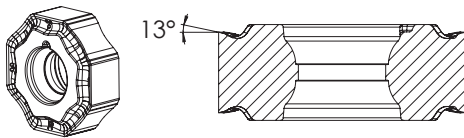

ONHX-LP
ONKX-LP

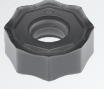

ONHX-MP
ONKX-MP



ONHX-W



INSERT SIZE
16 SN...
1606

SNHX-LP

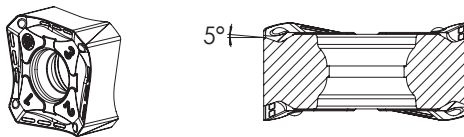

SNHX-MP
SNKX-MP

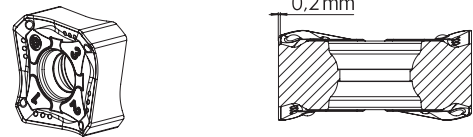

SNHX-MK
SNKX-MK

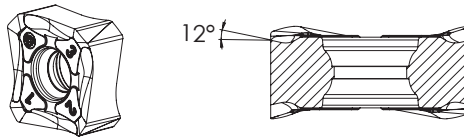

SNHX-LP

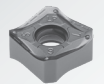

SNHX-MP
SNKX-MP

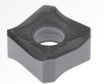

SNHX-MK
SNKX-MK

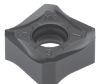

CHIP BREAKERS | Quebra- aparas | Rompevirutas

Chip Breaker	Features Características Características
Geometry LP Light machine	Positive top rake angle to promote a good chip flow and reduce power consumption on low alloy steels.
Geometry MP Light machine	Chip-breaker with a reinforced chamfer for general applications on steel and cast iron.
Geometry MK Light machine	Angles optimized for greater stability and durability of the edge in the machine of cast iron.
Geometry LN Light machine	High positive chip-breaker, polished for applications of non ferrous materials (aluminum).
Geometry W Light machine	Chip-breaker wiper for the best finishing solutions.

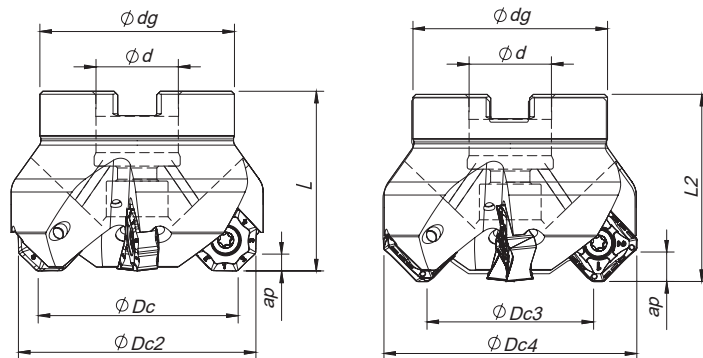

Arbor Mounting

$K_r=45^\circ$ | $\gamma_p=-6^\circ$

Order code Código	Reference Referência Referencia		Dimensions Dimensões Dimensiones (mm)								Kg	Specifications		Insert Pastilha Inserto	Stock
			ϕDc	$\phi Dc2$	$\phi Dc3$	$\phi Dc4$	ϕd	ϕdg	L	L2		Arbor Type	Ap (mm)		
181111400	050A90845-04-06-022040	4	50	57,6	47,1	62	22	48	40	41,5	0,383	A	3,5 6,0	ON...05 SN...12	
181117400	050A90845-06-06-022040	6	50	57,6	47,1	62	22	48	40	41,5	0,374	A	3,5 6,0	ON...05 SN...12	
181117500	063A90845-06-06-022040	6	63	70,6	60,1	75	22	52	40	41,5	0,525	A	3,5 6,0	ON...05 SN...12	
181117600	063A90845-08-06-022040	8	6	13,6	3,1	18	22	52	40	41,5	0,517	A	3,5 6,0	ON...05 SN...12	
181117700	080A90845-07-06-027050	7	80	87,6	77,1	92	27	60	50	51,5	0,846	B	3,5 6,0	ON...05 SN...12	
181117800	080A90845-10-06-027050	10	80	87,6	77,1	92	27	60	50	51,5	0,842	B	3,5 6,0	ON...05 SN...12	
181117900	100A90845-08-06-032050	8	100	107,6	97,1	112	32	80	50	51,5	1,559	B	3,5 6,0	ON...05 SN...12	
181120900	100A90845-12-06-032050	12	100	107,6	97,1	112	32	80	50	51,5	1,540	B	3,5 6,0	ON...05 SN...12	
181121000	125A90845-10-06-040063	10	125	132,6	122,1	137	40	90	63	64,5	2,890	B	3,5 6,0	ON...05 SN...12	
181121100	160A90845-12-06-U040063	12	160	167,6	157,1	172	40	110	63	64,5	4,360	C	3,5 6,0	ON...05 SN...12	
181121200	200A90845-14-06-U060063	14	200	207,6	197,1	212	60	172	63	64,5	8,890	C	3,5 6,0	ON...05 SN...12	
181121300	250A90845-16-06-U060063	16	250	257,6	247,1	262	60	172	63	64,5	11,490	C	3,5 6,0	ON...05 SN...12	

Stock item | Produto de stock | Itens de stock

Available under request | Disponível sobre consulta | Disponible bajo consulta

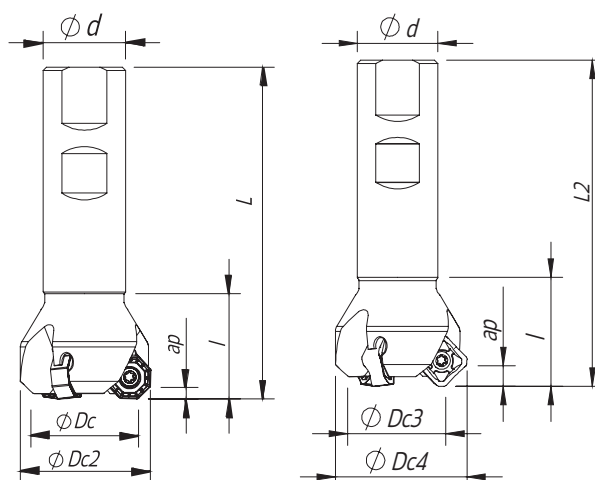

Weldon Shank

$K_r=45^\circ$ | $\gamma_p=-6^\circ$

Order code Código	Reference Referência Referencia		Dimensions Dimensões Dimensiones (mm)								Kg	Specifications		Insert Pastilha Inserto	Stock
			ϕDc	$\phi Dc2$	$\phi Dc3$	$\phi Dc4$	ϕd	L	L2	Ap (mm)					
181118000	032W90845-03-06-025100	3	32	39,6	29,1	44	25	100	101,5	0,375	3,5 6,0	ON...05 SN...12			
181118100	040W90845-04-06-032110	4	40	47,6	37,1	52	32	110	111,5	0,653	3,5 6,0	ON...05 SN...12			

Stock item | Produto de stock | Itens de stock

Available under request | Disponível sobre consulta | Disponible bajo consulta

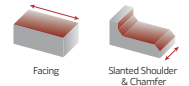

ONH(K)X 05 | SNH(K)X 12 | Inserts | Pastilhas | Plaquetas

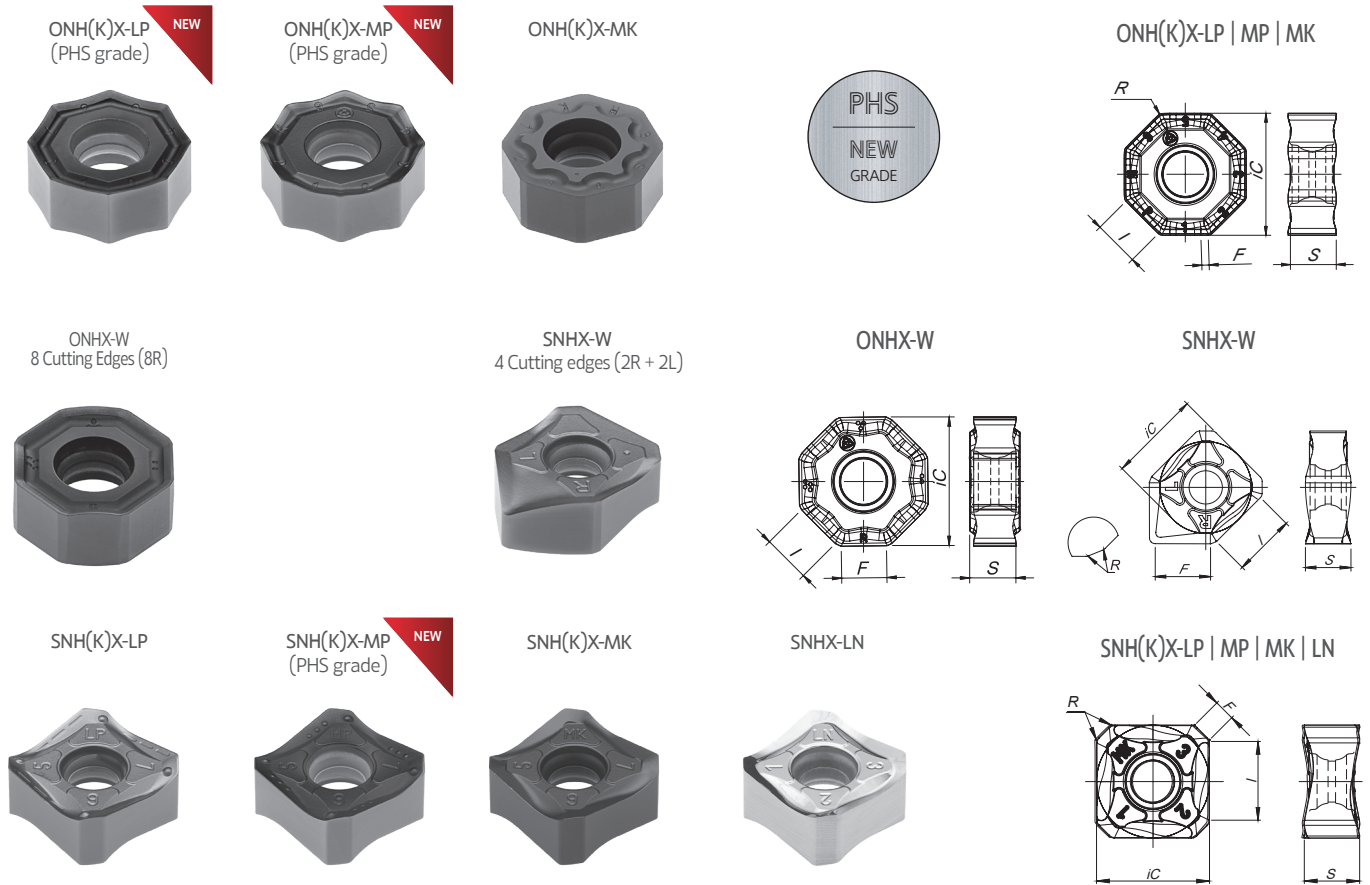

(1) Geometry code	ISO Reference	P						M			K			N		S		H	Dimensions Dimensões Dimensiones (mm)					
		CVD		PVD				CVD		PVD	CVD		PVD	UNC	PCD	PVD		PVD	iC	S	I	R	F	
		T9	P7	G1	G4	P3	G6	R1	P3	G6	L5	L6	L9	G1	G4	G6	10	D6						P3
1112302	ONHX 050505 ANEN-LP				⊗	⊗	⊗		⊗	⊗							⊗	⊗		12,70	5,20	5,30	0,50	-
1112304	ONHX 050505 ANSN-MP			○	○															12,70	5,20	5,30	0,50	-
1112306	ONHX 050500 ANEN-MK										○	○								12,70	5,20	5,30	-	-
NEW	1112301	ONKX 050505 ANEN-LP	⊗			⊗	⊗		⊗									⊗		12,70	5,20	5,30	0,50	-
NEW	1112303	ONKX 050505 ANSN-MP	⊗			⊗	⊗													12,70	5,20	5,30	0,50	-
	1112305	ONKX 050500 ANEN-MK									⊗	⊗								12,70	5,20	5,30	-	-
	1112307	ONHX 050500 ANER-W				⊗				⊗										12,70	5,20	5,30	-	4,30
	1111452	SNHX 1206 ANEN-LP				⊗	⊗		⊗									⊗		12,70	6,35	9,30	0,80	2,00
NEW	1111502	SNHX 1206 ANSN-MP	⊗		⊗	⊗	⊗													12,70	6,35	9,30	0,80	2,00
	1111503	SNHX 1206 ANEN-MK								⊗		⊗	⊗							12,70	6,35	9,30	0,80	2,00
	1111504	SNHX 1206 ANFN-LN															⊗			12,70	6,35	9,30	0,80	2,00
NEW	1112293	SNKX 1206 ANSN-MP	⊗			⊗		⊗												12,70	6,35	9,30	0,80	2,00
	1112249	SNKX 1206 ANEN-MK								⊗	⊗	⊗								12,70	6,35	9,30	0,80	2,00
	1111899	SNHX 1206 ANFN-W*			⊗	⊗											⊗	⊗		12,70	6,35	9,30	0,40	7,60

⊗ First choice | Primeira opção | 1ª opción ⊗ Stock item | Produto de stock | Itens de stock ○ Available under request | Disponível sobre consulta / Disponible bajo consulta Insert order code = (1) Geometry Code + (2) Grade Code

* Wiper insert with 2 rights and 2 left-hand cutting edges.

PLUS 90845

SPARE PARTS | Complementos | Repuestos

Cutter ØDc	Insert Screw	Key (Torx)	Order separately		Order separately	
			Key (Torx - Nm)	Torque Value	Screw	DIN 6368 Wrench
A90845 - 50 - 63	P0401200	XT15	DT1530	3,0	-	-
A90845 - 80	P0401200	XT15	DT1530	3,0	J0123510	SD6368-12
A90845 - 100	P0401200	PT15	DT1530	3,0	J0164110	SD6368-16
A90845 - 125	P0401200	PT15	DT1530	3,0	J0204610	SD6368-20
A90845 - 160 - 250	P0401200	PT15	DT1530	3,0	-	-
W90845 - 32 - 40	P0401200	XT15	DT1530	3,0	-	-

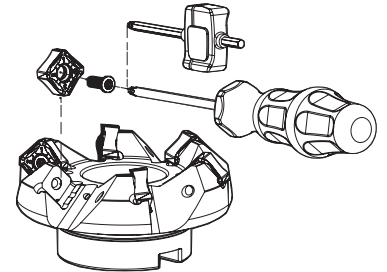

GRADES SELECTION GUIDE | Guia para selecção de graus | Tabla para selección de calidades

ISO	PSM	Material	HB (Brinell)	Grades						Toughness			
				← Wear Resistance						→			
				PH0910	PH5705	PH5320	PH7910	PH7920	PH7930	PH5740	PHS740	PH7740	
P	1	Unalloyed Steel	125-220	●	●	●	●	●	●	●	●	✓	✓
	2	Low-Alloyed Steel	220-280	●	●	●	●	●	●	●	●	✓	✓
	3	High-Alloyed Steel	280-380	●	●	●	●	●	●	●	●	✓	✓
M	4	SS - Ferritic / Martensitic	200-330	●	●	●	●	●	●	●	●	✓	✓
	5	SS - Austenitic	200-330	●	●	●	●	●	●	●	●	✓	✓
	6	SS - Austenitic-ferritic (Duplex)	230-260	●	●	●	●	●	●	●	●	✓	✓
K	7	Malleable Cast Iron	130-230	●	●	●	●	●	●	●	●	✓	✓
	8	Grey Cast Iron	180-245	●	●	●	●	●	●	●	●	✓	✓
	9	Nodular Cast iron	160-250	●	●	●	●	●	●	●	●	✓	✓
N	10	Aluminium and Non Ferrous	30-130	✓	●	●	●	●	●	●	●	●	●
S	11	Heat Resistant Super Alloys	200-320	●	●	●	●	●	●	●	●	●	✓

● Good Conditions

● Average Conditions

● Difficult Conditions

RECOMMENDED CUTTING CONDITIONS | Condições de corte recomendadas | Condiciones de corte recomendables

ISO	PSM	Material	HB (Brinell)	Vc (m/min)				
				← Wear Resistance			Toughness →	
				PH0910	PH5705	PH5320	PH7910	PH7920
P	1	Unalloyed Steel	125-220	-	-	-	190-280	180-250
	2	Low-Alloyed Steel	220-280	-	-	-	180-240	170-210
	3	High-Alloyed Steel	280-380	-	-	-	170-220	160-200
M	4	SS - Ferritic / Martensitic	200-330	-	-	-	-	-
	5	SS - Austenitic	200-330	-	-	-	-	-
	6	SS - Austenitic-ferritic (Duplex)	230-260	-	-	-	-	-
K	7	Malleable Cast Iron	130-230	-	190-340	180-320	180-320	170-300
	8	Grey Cast Iron	180-245	-	180-300	170-280	170-280	150-250
	9	Nodular Cast iron	160-250	-	140-250	130-250	100-240	90-210
N	10	Aluminium and Non Ferrous	30-130	350-1200	-	-	-	-
S	11	Heat Resistant Super Alloys	200-320	-	-	-	-	-

ISO	PSM	Material	HB (Brinell)	Vc (m/min)				Feed fz (mm/t)	
				← Wear Resistance		Toughness →			
				PH7930	PH5740	PH5740	PH7740	SNH(K)X 12...	ONH(K)X 05...
P	1	Unalloyed Steel	125-220	160-220	-	140-170	140-170	0,10-0,35	0,10-0,35
	2	Low-Alloyed Steel	220-280	150-180	-	130-160	130-160	0,10-0,35	0,10-0,35
	3	High-Alloyed Steel	280-380	130-160	-	110-140	110-140	0,10-0,30	0,10-0,30
M	4	SS - Ferritic / Martensitic	200-330	120-180	-	-	-	0,10-0,30	0,10-0,30
	5	SS - Austenitic	200-330	100-160	-	-	-	0,10-0,30	0,10-0,30
	6	SS - Austenitic-ferritic (Duplex)	230-260	70-140	-	-	-	0,10-0,25	0,10-0,25
K	7	Malleable Cast Iron	130-230	160-280	170-300	-	130-250	0,10-0,35	0,10-0,35
	8	Grey Cast Iron	180-245	140-240	150-260	-	110-220	0,10-0,35	0,10-0,35
	9	Nodular Cast iron	160-250	90-200	130-220	-	80-170	0,10-0,30	0,10-0,30
N	10	Aluminium and Non Ferrous	30-130	-	-	-	-	0,10-0,35	-
S	11	Heat Resistant Super Alloys	200-320	30-75	-	-	-	0,07-0,20	0,07-0,18

(Note 1) Cutting conditions $a_e/D_c=70\%$.

(Note 2) It's possible to occur vibrations in certain cases. Please reduce depth of cut and / or reduce cutting conditions in following cases:

- When using long shank;
- When using long tool overhang with arbor type;
- When application has poor clamping rigidity or when using a low rigidity machine.

(Note 3) PH5... and PH5... can be used wet or dry. PH7... use only air.

CHIP-BREAKER SELECTION GUIDE | Guia para aplicações do quebra-apanas | Guía para aplicación del rompevirutas

ISO	PSM	Material	HB (Brinell)	Chip-Breaker Application	
				1st choice	Difficult Operations
P	1	Unalloyed Steel	125-220	LP	MP
	2	Low-Alloyed Steel	220-280	LP	MP
	3	High-Alloyed Steel	280-380	MP	-
M	4	SS - Ferritic / Martensitic	200-330	LP	MP
	5	SS - Austenitic	200-330	LP	-
	6	SS - Austenitic-ferritic (Duplex)	230-260	LP	-
K	7	Malleable Cast Iron	130-230	MK	-
	8	Grey Cast Iron	180-245	MK	-
	9	Nodular Cast iron	160-250	MK	-
N	10	Aluminium and Non Ferrous	30-130	LN	-
S	11	Heat Resistant Super Alloys	200-320	LP	-



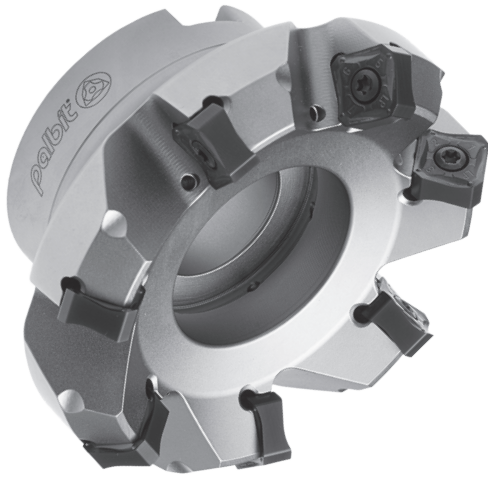

Arbor Mounting
 $K_r=45^\circ$ | $\gamma_p=-6^\circ$

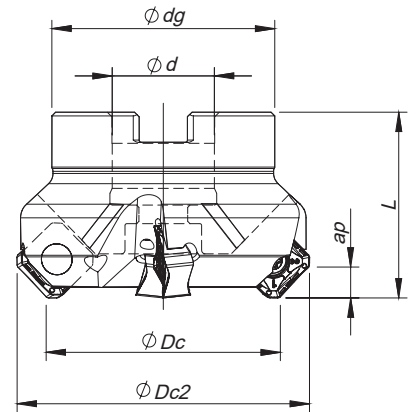

Order code Código	Reference Referência Referencia		Dimensions Dimensões Dimensiones (mm)					Kg	Specifications		Insert Pastilha Inserto	Stock
			ØDc	ØDc2	Ød	Ødg	L		Arbor Type	Ap max (mm)		
181048200	050A90945-04-06-022040	4	50	63	22	48	40	0,424	A	6,0	SN... 1206	
181067000	050A90945-06-06-022040	6	50	63	22	48	40	0,415	A	6,0	SN... 1206	
181048300	063A90945-06-06-022040	6	63	76	22	52	40	0,575	A	6,0	SN... 1206	
181067100	063A90945-08-06-022040	8	63	76	22	52	40	0,577	A	6,0	SN... 1206	
181048400	080A90945-07-06-027050	7	80	93	27	60	50	0,966	B	6,0	SN... 1206	
181067200	080A90945-10-06-027050	10	80	93	27	60	50	0,950	B	6,0	SN... 1206	
181048500	100A90945-08-06-032050	8	100	113	32	80	50	1,667	B	6,0	SN... 1206	
181067300	100A90945-12-06-032050	12	100	113	32	80	50	1,650	B	6,0	SN... 1206	
181048600	125A90945-10-06-040063	10	125	138	40	90	63	2,890	B	6,0	SN... 1206	
181048700	160A90945-12-06-U040063	12	160	173	40	110	63	4,360	C	6,0	SN... 1206	
181052800	200A90945-14-06-U060063	14	200	213	60	172	63	8,890	C	6,0	SN... 1206	
181064700	250A90945-16-06-U060063	16	250	263	60	172	63	11,490	C	6,0	SN... 1206	

Stock item | Produto de stock | Itens de stock

Available under request | Disponível sobre consulta | Disponible bajo consulta

SPARE PARTS | Complementos | Repuestos

Cutter ØDc	Insert Screw	Key (Torx)	Order separately		Order separately	
			Key (Torx - Nm)	Torque Value	Screw	DIN 6368 Wrench
A90945 - 50 - 63	P0401200	XT15	DT1530	3,0	-	-
A90945 - 80	P0401200	XT15	DT1530	3,0	J0123510	SD6368-12
A90945 - 100	P0401200	PT15	DT1530	3,0	J0164110	SD6368-16
A90945 - 125	P0401200	PT15	DT1530	3,0	J0204610	SD6368-20
A90945 - 160 - 250	P0401200	PT15	DT1530	3,0	-	-

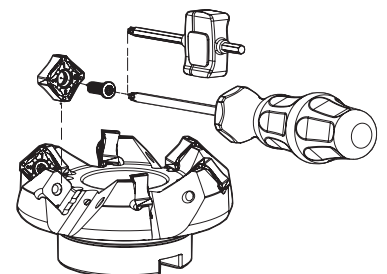

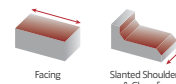

SNH(K)X 1206 | Inserts | Pastilhas | Plaquetas

SNH(K)X-LP

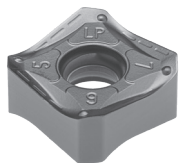

SNH(K)X-MP
(PHS grade)

NEW

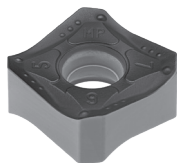

SNH(K)X-LP | MP | MK | LN

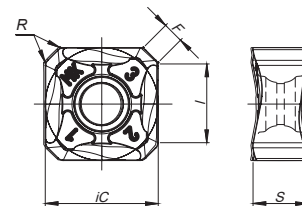

SNH(K)X-MK

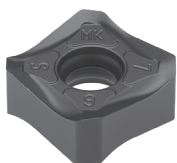

SNHX-LN



SNHX-W

4 Cutting edges (2R + 2L)



SNHX-W

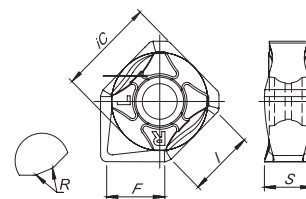

	(2) Grade code	P						M				K			N	S	H	Dimensions Dimensões Dimensiones (mm)														
		CVD			PVD			CVD		PVD		CVD			PVD			UNC	PCD	PVD		PVD	iC	S	I	R	F					
		T9	P7	G1	G4	P3	G6	R1	G4	P3	G6	L5	L6	L9	G1	G4	P3	10	D6	P3	G6	P7										
(1) Geometry code	ISO Reference	PH5740	PH7603	PH7910	PH7920	PH7930	PH7740	PHM740	PH7920	PH7930	PH7740	PH5705	PH5320	PH5740	PH7910	PH7920	PH7930	PH0910	PDP410	PH7930	PH7740	PH7603										
NEW	1112293	SNKX 1206 ANSN-MP	⊗			⊗	⊗																					12,70	6,35	9,30	0,80	2,00
	1112249	SNKX 1206 ANEN-MK										⊗	⊗	⊗														12,70	6,35	9,30	0,80	2,00
	1111452	SNHX 1206 ANEN-LP				⊗	⊗			⊗						⊗	⊗			⊗								12,70	6,35	9,30	0,80	2,00
NEW	1111502	SNHX 1206 ANSN-MP	⊗		⊗	⊗	⊗																					12,70	6,35	9,30	0,80	2,00
	1111503	SNHX 1206 ANEN-MK										⊗		⊗	⊗	⊗												12,70	6,35	9,30	0,80	2,00
	1111504	SNHX 1206 ANFN-LN																⊗										12,70	6,35	9,30	0,80	2,00
	1111899	SNHX 1206 ANFN-W*			⊗	⊗										⊗	⊗											12,70	6,30	9,30	0,40	7,60

⊗ First choice | Primeira opção | 1ª opción

⊗ Stock item | Produto de stock | Itens de stock

○ Available under request | Disponível sobre consulta
Disponível bajo consulta

Insert order code = (1) Geometry Code + (2) Grade Code

* Wiper insert with 2 rights and 2 left-hand cutting edges.

PLUS 90945

RECOMMENDED CUTTING CONDITIONS | Condições de corte recomendadas | Condiciones de corte recomendables

ISO	PSM	Material	HB (Brinell)	Vc (m/min)				
				← Wear Resistance				
				PH0910	PH5705	PH7910	PH7920	PH7930
P	1	Unalloyed Steel	125-220	-	-	190-280	180-250	160-220
	2	Low-Alloyed Steel	220-280	-	-	180-240	170-210	150-180
	3	High-Alloyed Steel	280-380	-	-	170-220	160-200	130-160
M	4	SS - Ferritic / Martensitic	200-330	-	-	-	-	120-180
	5	SS - Austenitic	200-330	-	-	-	-	100-160
	6	SS - Austenitic-ferritic (Duplex)	230-260	-	-	-	-	70-140
K	7	Malleable Cast Iron	130-230	-	190-340	180-320	170-300	160-280
	8	Grey Cast Iron	180-245	-	180-300	170-280	150-250	140-240
	9	Nodular Cast iron	160-250	-	140-250	100-240	90-210	90-200
N	10	Aluminium and Non Ferrous	30-130	350-1200	-	-	-	-
S	11	Heat Resistant Super Alloys	200-320	-	-	-	-	30-75

(Note 1) Cutting conditions $a_e/D_c=70\%$.

(Note 2) It's possible to occur vibrations in certain cases. Please reduce depth of cut and / or reduce cutting conditions in following cases:

- When using long shank;
- When using long tool overhang with arbor type;
- When application has poor clamping rigidity or when using a low rigidity machine.

(Note 3) PH5... and PHS... can be used wet or dry. PH7... use only air.

GRADES SELECTION GUIDE | Guia para selecção de graus | Tabla para selección de calidades

ISO	PSM	Material	HB (Brinell)	Grades							
				← Wear Resistance					Toughness →		
				PH0910	PH5705	PH7910	PH7920	PH7930	PH5740	PHS740	PH7740
P	1	Unalloyed Steel	125-220	●	●	●	●	●	●	●	●
	2	Low-Alloyed Steel	220-280			●	●	●		●	●
	3	High-Alloyed Steel	280-380			●	●	●		●	●
M	4	SS - Ferritic / Martensitic	200-330					●			
	5	SS - Austenitic	200-330					●			
	6	SS - Austenitic-ferritic (Duplex)	230-260					●			
K	7	Malleable Cast Iron	130-230		●		●		●		
	8	Grey Cast Iron	180-245		●		●		●		
	9	Nodular Cast iron	160-250		●		●		●		
N	10	Aluminium and Non Ferrous	30-130	●							
S	11	Heat Resistant Super Alloys	200-320					●			

- Good Conditions
- Average Conditions
- Difficult Conditions

CHIP-BREAKER SELECTION GUIDE | Guia para aplicações do quebra- aparas | Guía para aplicación del rompevirutas

ISO	PSM	Material	HB (Brinell)	Chip-Breaker Application	
				1st choice	Difficult Operations
P	1	Unalloyed Steel	125-220	SNHX 12... LP	SNH(K)X 12... MP
	2	Low-Alloyed Steel	220-280	SNHX 12... LP	SNH(K)X 12... MP
	3	High-Alloyed Steel	280-380	SNH(K)X 12... MP	-
M	4	SS - Ferritic / Martensitic	200-330	SNHX 12... LP	-
	5	SS - Austenitic	200-330	SNHX 12... LP	-
	6	SS - Austenitic-ferritic (Duplex)	230-260	SNHX 12... LP	-
K	7	Malleable Cast Iron	130-230	SNH(K)X 12... MK	-
	8	Grey Cast Iron	180-245	SNH(K)X 12... MK	-
	9	Nodular Cast iron	160-250	SNH(K)X 12... MK	-
N	10	Aluminium and Non Ferrous	30-130	SNHX 12... LN	-
S	11	Heat Resistant Super Alloys	200-320	SNHX 12... LP	-

Vc (m/min)			Feed fz (mm/t)				
		Toughness →					
PH5740	PHS740	PH7740	SNHX 12... LP	SNH(K)X 12... MP	SNH(K)X 12... MK	SNHX 12... LN	SNHX 12... W
-	140-170	140-170	0,10-0,35	0,10-0,35	-	-	0,10-0,35
-	130-160	130-160	0,10-0,35	0,10-0,35	-	-	0,10-0,35
-	110-140	110-140	0,10-0,30	0,10-0,30	-	-	0,10-0,30
-	-	-	0,10-0,30	-	-	-	-
-	-	-	0,10-0,30	-	-	-	-
-	-	-	0,10-0,25	-	-	-	-
170-300	-	130-250	0,10-0,35	-	0,10-0,35	-	0,10-0,40
150-260	-	110-220	0,10-0,35	-	0,10-0,35	-	0,10-0,40
130-220	-	80-170	0,10-0,30	-	0,10-0,30	-	0,10-0,40
-	-	-	-	-	-	0,10-0,35	-
-	-	-	0,07-0,20	-	-	-	-

WIPER INSERTS

Recommended Cutting Conditions:

- f_z should be equal to $0,8 \times F_w / Z$
- Axial depth of cut is 0,5 to 0,8mm.

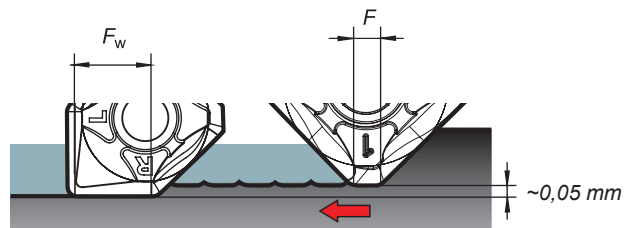

Example:

- The width of the parallel land (F) of the insert is 2mm.
- To obtain a good surface finishing, the feed per revolution should be a maximum of 80% of 2mm = 1,6mm.
- The wiper insert will have a parallel land (F_w) with a width of 7,6mm.
- Result: Feed per revolution (f_r) could be increased from 1,6mm to 6,1mm (80% of 7,6mm).

Note: Other limitations, such as machine power, must be taken into consideration.

How to use a wiper insert:

- Since wiper is one corner use to standard cutters, please attach the insert with the parallel land down to the workspace cutting surface.

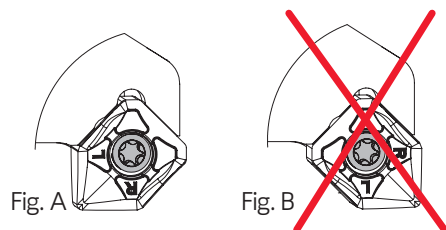

When using wiper insert, install the insert as shown on Fig. A if the insert is installed as shown on Fig. B breakage of the insert is inevitable and normal surface finish can not be obtained.

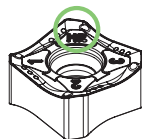

This point shows the SNKX insert difference to SNHX

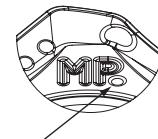

Put the same side of insert in each pocket for best radial and axial runout when using SNKX.

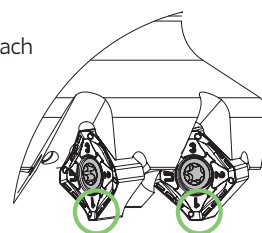

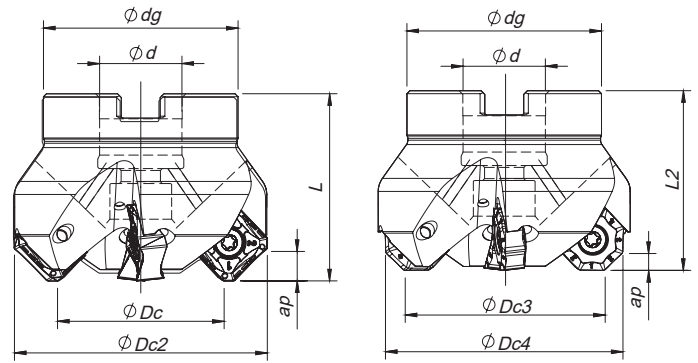
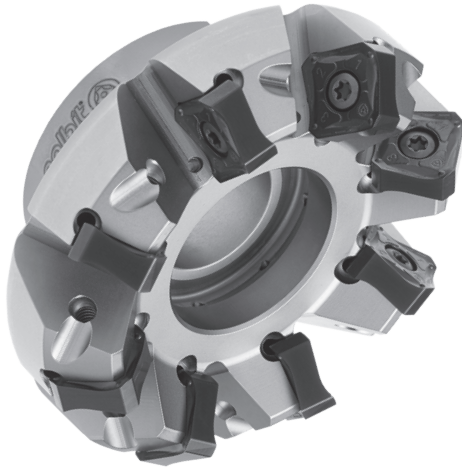

Arbor Mounting
 $K_r = 45^\circ$ | $\gamma_p = -6^\circ$

Order code Código	Reference Referência Referencia		Dimensions Dimensões Dimensiones (mm)								Kg	Specifications		Insert Pastilha Inserto	Stock
			ϕDc	$\phi Dc2$	$\phi Dc3$	$\phi Dc4$	ϕd	ϕdg	L	L2		Arbor Type	Ap (mm)		
181088900	063A91245-05-06-022050	5	63	80,1	66,6	76,0	22	52	50	48	0,81	A	3,8 8,5	ON...06 SN...16	
181089000	080A91245-06-06-027050	6	80	97,1	83,6	93,0	27	60	50	48	1,06	B	3,8 8,5	ON...06 SN...16	
181089100	080A91245-08-06-027050	8	80	97,1	83,6	93,0	27	60	50	48	1,09	B	3,8 8,5	ON...06 SN...16	
181089200	100A91245-07-06-032063	7	100	117,1	103,6	113,0	32	80	63	61	2,24	B	3,8 8,5	ON...06 SN...16	
181089300	100A91245-10-06-032063	10	100	117,1	103,6	113,0	32	80	63	61	2,28	B	3,8 8,5	ON...06 SN...16	
181089400	125A91245-08-06-040063	8	125	142,1	128,6	138,0	40	90	63	61	3,04	B	3,8 8,5	ON...06 SN...16	
181089500	160A91245-10-06-U040063	10	160	177,1	163,6	173,0	40	110	63	61	4,40	C	3,8 8,5	ON...06 SN...16	
181089600	200A91245-12-06-U060063	12	200	217,1	203,6	213,0	60	172	63	61	9,12	C	3,8 8,5	ON...06 SN...16	
181089700	250A91245-14-06-U060063	14	250	267,1	253,6	263,0	60	172	63	61	11,93	C	3,8 8,5	ON...06 SN...16	

Stock item | Produto de stock | Itens de stock

Available under request (separate A-6) | Disponível sob consulta (consulta a página A-6) | Disponible bajo consulta (mire pagina A-6)

SPARE PARTS | Complementos | Repuestos

Cutter ϕDc	Insert Screw	Key (Torx)	Order separately		Order separately	
			Key (Torx - Nm)	Torque Value	Screw	DIN 6368 Wrench
A91245 - 63	P0451400	XT20	DT2050	5,0	-	-
A91245 - 80	P0451400	XT20	DT2050	5,0	J0123510	SD6368-12
A91245 -100	P0451400	PT20	DT2050	5,0	J0164110	SD6368-16
A91245 -125	P0451400	PT20	DT2050	5,0	J0204610	SD6368-20
A91245 - 160-250	P0451400	PT20	DT2050	5,0	-	-

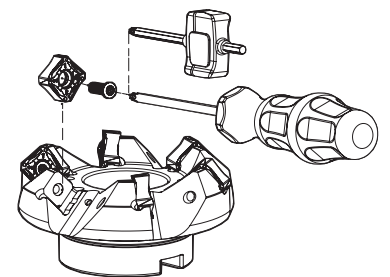

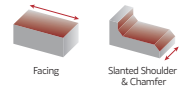

ONH(K)X 0606 | SNH(K)X 1606 | Inserts | Pastilhas | Plaquetas

ONH(K)X-LP



ONH(K)X-MP
(PHS grade)

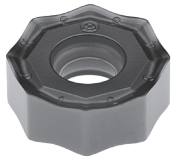

ONH(K)X-MK



ONH(K)X-LP | MP | MK

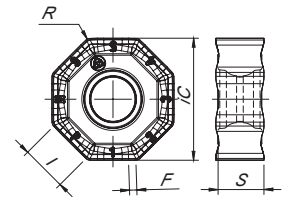

ONHX-W
(8 Cutting edges (4R + 4L))



ONHX-W

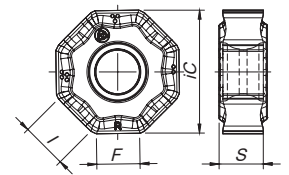

SNH(K)X-LP



SNH(K)X-MP
(PHS grade)

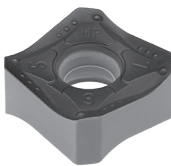

SNH(K)X-MK

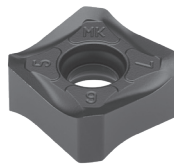

SNH(K)X-LP | MP | MK

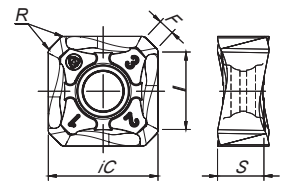

(1) Geometry code	(2) Grade code ISO Reference	P					M				K				N		S		H	Dimensions Dimensões Dimensiones (mm)							
		CVD		PVD			CVD		PVD		CVD		PVD		UNC	PCD	PVD		PVD	IC	S	I	R	F			
		T9	G1	G4	P3	G6	R1	G4	P3	G6	L5	L6	L9	G1	G4	P3	G6	10	D6						P3	G6	P7
1111954	ONHX 0606 ANEN-LP			⊗	⊗	⊗																	16,50	6,35	6,20	0,80	1,00
1111955	ONHX 0606 ANEN-MP	○		⊗		⊗																	16,50	6,35	6,20	0,80	1,00
1111956	ONHX 0606 ANEN-MK											⊗		⊗									16,50	6,35	6,20	0,80	1,00
1112053	ONHX 0606 ANEN-W*			⊗																			16,50	6,35	6,20	-	6,00
1112284	ONKX 0606 ANEN-LP			⊗	⊗	⊗																	16,50	6,35	6,20	0,80	1,00
NEW	1112287	ONKX 0606 ANEN-MP	⊗		⊗		⊗																16,50	6,35	6,20	0,80	1,00
	1112291	ONKX 0606 ANEN-MK										⊗		⊗									16,50	6,35	6,20	0,80	1,00
	1111951	SNHX 1606 ANER-LP			⊗	⊗	⊗																16,50	6,35	12,50	0,80	2,20
NEW	1111952	SNHX 1606 ANER-MP	⊗		⊗		⊗																16,50	6,35	12,50	0,80	2,20
	1111953	SNHX 1606 ANER-MK																					16,50	6,35	12,50	0,80	2,20
NEW	1112281	SNKX 1606 ANER-MP	⊗		⊗		⊗																16,50	6,35	12,50	0,80	2,20
	1112282	SNKX 1606 ANER-MK																					16,50	6,35	12,50	0,80	2,20

⊗ First choice | Primeira opção | 1ª opción

⊗ Stock item | Produto de stock | Itens de stock

○ Available under request | Disponível sobre consulta
Disponível bajo consulta

Insert order code = (1) Geometry Code + (2) Grade Code

* Wiper insert with 4 rights and 4 left-hand cutting edges.

GRADES SELECTION GUIDE | Guia para selecção de graus | Tabla para selección de calidades

ISO	PSM	Material	HB (Brinell)	Grades					
				← Wear Resistance			Toughness →		
				PH5705	PH7920	PH7930	PH5740	PH5740	PH7740
P	1	Unalloyed Steel	125-220	●	✓	✓	●	✓	✓
	2	Low-Alloyed Steel	220-280		✓	✓		✓	✓
	3	High-Alloyed Steel	280-380		✓	✓		✓	✓
M	4	SS - Ferritic / Martensitic	200-330			✓			✓
	5	SS - Austenitic	200-330			✓			✓
	6	SS - Austenitic-ferritic (Duplex)	230-260			✓			✓
K	7	Malleable Cast Iron	130-230	✓	✓		✓		
	8	Grey Cast Iron	180-245	✓	✓		✓		
	9	Nodular Cast iron	160-250	✓	✓		✓		
S	11	Heat Resistant Super Alloys	200-320			✓			✓

● Good Conditions
 ● Average Conditions
 ● Difficult Conditions

RECOMMENDED CUTTING CONDITIONS | Condições de corte recomendadas | Condiciones de corte recomendables

ISO	PSM	Material	HB (Brinell)	Vc (m/min)		
				← Wear Resistance		Toughness →
				PH5705	PH7920	PH7930
P	1	Unalloyed Steel	125-220	-	180 (260) 320	-
	2	Low-Alloyed Steel	220-280	-	150 (200) 240	-
	3	High-Alloyed Steel	280-380	-	140 (180) 200	-
M	4	SS - Ferritic / Martensitic	200-330	-	-	120 (180) 200
	5	SS - Austenitic	200-330	-	-	100 (140) 180
	6	SS - Austenitic-ferritic (Duplex)	230-260	-	-	90 (110) 140
K	7	Malleable Cast Iron	130-230	170 (190) 305	-	-
	8	Grey Cast Iron	180-245	180 (280) 350	-	-
	9	Nodular Cast iron	160-250	130 (160) 210	-	-
S	11	Heat Resistant Super Alloys	200-320	-	-	35 (50) 75

ISO	PSM	Material	HB (Brinell)	Vc (m/min)			Feed fz (mm/t)
				← Wear Resistance		Toughness →	SNH(K)X/ONH(K)X
				PH5740	PH5740	PH7740	
P	1	Unalloyed Steel	125-220	-	160 (200) 240	160 (200) 240	0,15 (0,25) 0,4
	2	Low-Alloyed Steel	220-280	-	140 (160) 200	140 (160) 200	0,15 (0,25) 0,4
	3	High-Alloyed Steel	280-380	-	120 (140) 170	120 (140) 170	0,15 (0,25) 0,4
M	4	SS - Ferritic / Martensitic	200-330	-	-	110 (140) 160	0,1 (0,20) 0,3
	5	SS - Austenitic	200-330	-	-	90 (120) 140	0,1 (0,20) 0,3
	6	SS - Austenitic-ferritic (Duplex)	230-260	-	-	80 (100) 120	0,1 (0,20) 0,3
K	7	Malleable Cast Iron	130-230	150 (170) 260	-	-	0,15 (0,25) 0,4
	8	Grey Cast Iron	180-245	155 (190) 290	-	-	0,14 (0,25) 0,4
	9	Nodular Cast iron	160-250	115 (140) 180	-	-	0,14 (0,25) 0,4
S	11	Heat Resistant Super Alloys	200-320	-	-	20 (40) 55	0,1 (0,15) 0,17

(Note 1) Cutting conditions $a_e/D_c=70\%$.

(Note 2) It's possible to occur vibrations in certain cases. Please reduce depth of cut and / or reduce cutting conditions in following cases:

- When using long shank;
- When using long tool overhang with arbor type;
- When application has poor clamping rigidity or when using a low rigidity machine.

(Note 3) PH5... and PH5... can be used wet or dry. PH7... use only air.

Selection Example:

ISO	PSM	Material	HB (Brinell)	Vc (m/min)		Feed fz (mm/t)
				← Wear Resistance		Toughness →
				PH5705	PH5740	SNHX/ONHX
K	7	Malleable cast iron	130-230	170 (190) 305	150 (170) 260	0,15 (0,25) 0,40
	8	Grey cast iron	180-245	180 (280) 350	155 (190) 290	0,14 (0,25) 0,40
	9	Nodular cast iron	160-250	130 (160) 210	115 (140) 180	0,14 (0,25) 0,40

This example shows the recommended starting cutting conditions, indicated in Bold type.

CHIP-BREAKER SELECTION GUIDE | Guia para aplicações do quebra-afaras | Guía para aplicación del rompevirutas

ISO	PSM	Material	HB (Brinell)	Chip-Breaker Application	
				1 st choice	Alternative
P	1	Unalloyed Steel	125-220	LP	MP
	2	Low-Alloyed Steel	220-280	LP	MP
	3	High-Alloyed Steel	280-380	MP	-
M	4	SS - Ferritic / Martensitic	200-330	LP	-
	5	SS - Austenitic	200-330	LP	-
	6	SS - Austenitic-ferritic (Duplex)	230-260	LP	-
K	7	Malleable Cast Iron	130-230	MK	-
	8	Grey Cast Iron	180-245	MK	-
	9	Nodular Cast iron	160-250	MK	LP
S	11	Heat Resistant Super Alloys	200-320	LP	-

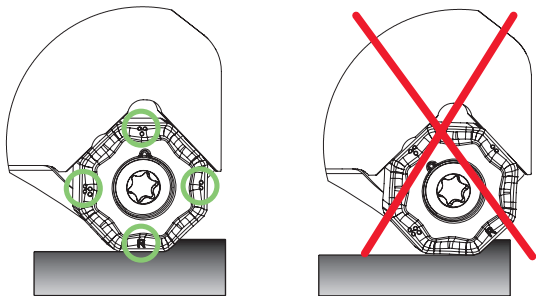

The points and letter (R or L) on the insert indicates the side that should be parallel to the workspace material.

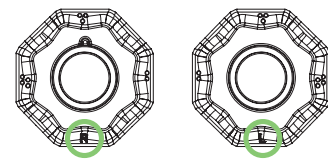

Wiper insert with 4 Right and 4 Left-hand cutting edges. The side work of the insert it's indicated by the letter R (Right) & L (Left).

WIPER INSERTS

Recommended Cutting Conditions:

- f_z should be equal to $0,8 \times F_w / Z$
- Axial depth of cut is 0,5 to 0,8mm.

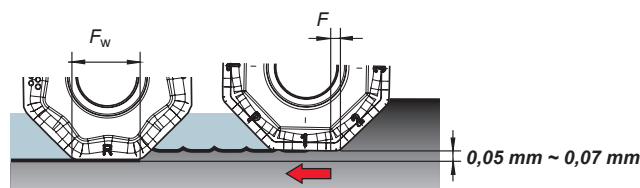

Example:

- The width of the parallel land (F) of the insert is 1mm.
- To obtain a good surface finishing, the feed per revolution should be a maximum of 80% of 1mm = 0,8mm.
- The wiper insert will have a parallel land (F_w) with a width of 6,0mm.
- Result: Feed per revolution (f_r) could be increased from 0,8mm to 4,8mm (80% of 6,0mm).

Note: Other limitations, such as machine power, must be taken into consideration.

How to use a wiper insert:

- Since wiper is one corner use to standard cutters, please attach the insert with the parallel land down to the workspace cutting surface.
- The points and the letter (R or L) on the insert indicates the side that should be parallel to the workspace material.
- The side work of the insert it's indicated by the letter (R - Right & L - Left).





PLUS
90845 | 90945 | 91245

HEADQUARTERS

PALBIT, S.A.

P.O.Box 4 - Palhal

3854-908 - Branca ALB - Portugal

T (+351) 234 540 300 | F (+351) 234 540 301

palbit@palbit.pt

www.palbit.pt

Branch office:

PALBIT México

Emerson 150. Int.803-804. Colonia Chapultepec

Morales Delagación Miguel Hidalgo

C.P. 11570 México DF

T (+52) 5555 454 543 | F (+52) 5552 509 190

info@palbit.com.mx | www.palbit.com.mx



SINCE 1916